

Lecture 7

Origins of Biopotentials: Excitable Cells

References

Webster, Ch. 4 (Sec. 4.1, 4.2).

http://en.wikipedia.org/wiki/Resting_potential

http://en.wikipedia.org/wiki/Action_potential

ORIGIN OF BIOPOTENTIALS

Webster, Chap. 4

- Biopotential : a voltage measurable on a body or other biological system

→ ECG : electrocardiogram (heart)

→ EMG : electromyogram (muscle)

→ EEG : electroencephalogram (brain)

etc...

- Biopotentials are produced by the combined effect of chemical activity (ION TRANSPORT) in large numbers of EXCITABLE CELLS:

→ muscle contractive tissue:

- cardiac muscle (heart)
 - skeletal muscle (locomotion)
 - smooth (non-striated) muscle (stomach, intestines, blood vessels, lungs, ...)
- } striated (fibers)

→ sensory and motor nerves in peripheral nervous system (PNS):

- somatic nervous system → touch and motor control (conscious)
- autonomic nervous system → sensing and control (unconscious) of cardiovascular, digestive, and other body functions.

→ neurons in central nervous system (CNS):

- brain
- spinal cord (extension of the brain to the PNS)
- retina (rods and cones photoreceptors: light transducers)
- cochlea (inner and outer hair cells: sound transducers)

— Electrical activity of excitable cells :

→ By default, excitable cells are at the RESTING VOLTAGE (in the RESTING STATE).

→ When excited, they produce an ACTION POTENTIAL (EXCITED STATE).

• Resting voltage :

Transmembrane potential of a cell arises due to differences in ionic concentrations, as well as diffusion across a membrane

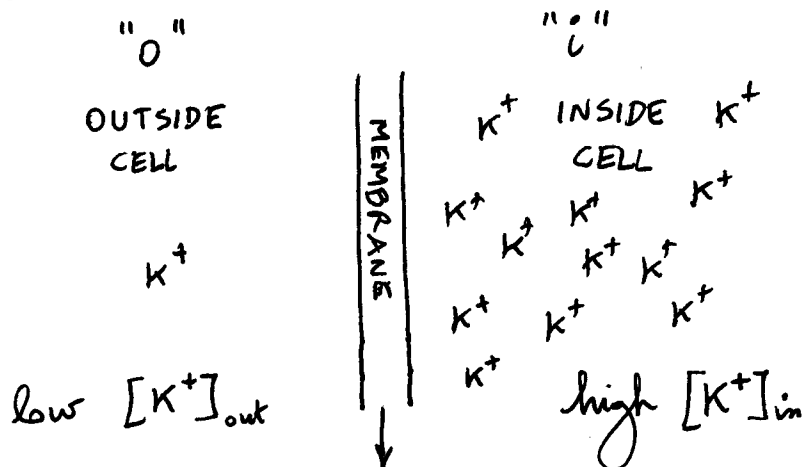

separates the ionic solutions inside and outside the cell, and limits the TRANSPORT of ions across.

At rest, the NET TRANSPORT of ions across the membrane is zero. This gives rise to a RESTING POTENTIAL DIFFERENCE (voltage) across the membrane.

This resting potential difference is given by the NERNST EQUATION (or "Nernst potential"):

$$E_K = \frac{RT}{n_K F} \ln \frac{[K^+]_o}{[K^+]_i}$$

↓
INSIDE minus
OUTSIDE potential.

Specifically for K^+
(different for other ions)

where $\left\{ \begin{array}{l} T = \text{temperature} \\ n_K = \text{valence} (= 1 \text{ for } K^+) \\ R = \text{gas constant} \\ F = \text{Faraday's constant} \end{array} \right.$

$\frac{R}{F}$ is sometimes written as $\frac{k}{q}$

$\left\{ \begin{array}{l} k = \text{Boltzmann constant} \\ q = \text{elementary charge} \end{array} \right.$

At body temperature: $\frac{RT}{F} = \frac{kT}{q} \approx 26 \text{ mV}$

$$\Rightarrow E_K \approx 26 \text{ mV} \cdot \ln \frac{[K^+]_o}{[K^+]_i} = 62 \text{ mV} \cdot \log_{10} \frac{[K^+]_o}{[K^+]_i}$$

↓
26 mV · ln(10)

Example: $[K^+]_o = 1 \text{ mmol/L}$
 $[K^+]_i = 100 \text{ mmol/L} \Rightarrow \log_{10} \frac{[K^+]_o}{[K^+]_i} = -2 \Rightarrow E_K = -124 \text{ mV}$
(inside is negative w.r.t. outside)

The same Nernst equation governs the potential difference for other ION TYPES Na^+ , Cl^- , Ca^{++} etc, with differences in the VALENCE besides the concentrations.

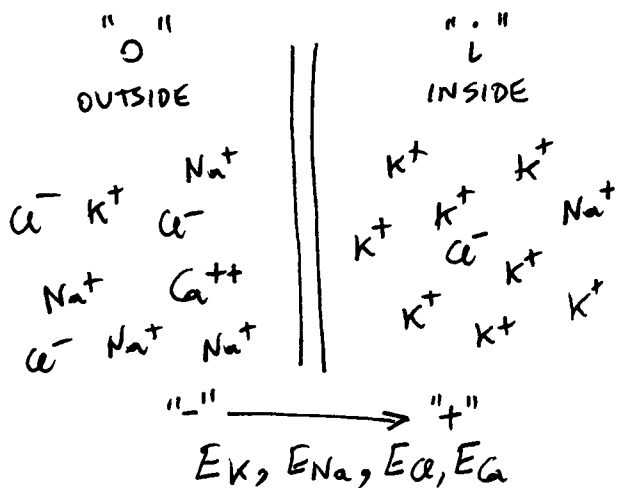

$$E_K = \frac{RT}{m_K F} \ln \frac{[K^+]_o}{[K^+]_i} \quad \text{where } m_K = 1$$

$$E_{Na} = \frac{RT}{m_{Na} F} \ln \frac{[Na^+]_o}{[Na^+]_i} \quad m_{Na} = 1$$

$$E_{Cl} = \frac{RT}{m_{Cl} F} \ln \frac{[Cl^-]_o}{[Cl^-]_i} \quad m_{Cl} = -1$$

$$E_{Ca} = \frac{RT}{m_{Ca} F} \ln \frac{[Ca^{++}]_o}{[Ca^{++}]_i} \quad m_{Ca} = +2$$

A Nernst potential can only be measured as a voltage across the membrane, if the membrane is PERMEABLE to that ion type. The degree to which the membrane lets these ions through, is the PERMEABILITY (P) for that ion type.

→ By default, the ionic solutions inside and outside the cell are electrically balanced (charge neutral): equal numbers of anions and cations.

→ Ion transport because of diffusion across a permeable membrane gives rise to a net charge, and thus voltage, across the membrane.

e.g., K^+ :

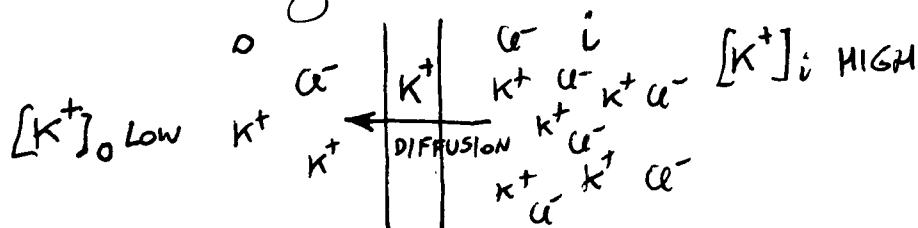

(+) → (-) ⇒ negative E_K
(Electric field)

→ When a membrane is permeable to only one ion type (such as K^+), then the Nernst potential is measured.

→ In general, the equilibrium (resting) potential of the cell depends on the permeabilities of its membrane to the various ion types; as given by the Goldman-Hodgkin-Katz (GHK) equation:

$$E = \frac{RT}{F} \cdot \ln \frac{P_K [K^+]_o + P_{Na} [Na^+]_o + P_{Cl} [Cl^-]_i}{P_K [K^+]_i + P_{Na} [Na^+]_i + P_{Cl} [Cl^-]_o}$$

where P_K = permeability to K^+
 P_{Na} = permeability to Na^+
 P_{Cl} = permeability to Cl^-

Example: If $P_K = P_{Na} = 0$ and $P_{Cl} = 4 \cdot 10^{-8} \text{ m/s}$ (permeable to Cl^- only), then

$$E = \frac{RT}{F} \ln \frac{P_{Cl} [Cl^-]_i}{P_{Cl} [Cl^-]_o} = -\frac{RT}{F} \ln \frac{[Cl^-]_o}{[Cl^-]_i}$$

$$= \frac{RT}{m_{Cl} F} \ln \frac{[Cl^-]_o}{[Cl^-]_i} = E_{Cl} \quad \text{where } m_{Cl} = -1$$

OK!

Typically, E is negative ($\approx -100 \text{ mV} \rightarrow -60 \text{ mV}$) for most excitable cells at resting state ($\approx -85 \text{ mV}$ for muscle).

- Action potential:

→ Ion pumps in the membrane constantly maintain the ion concentrations, keeping their Nernst potentials fixed (think of these as the power supply batteries of biology).

→ In an excitable cell, the permeabilities, or conductances, for the ion types each change with voltage to generate a spike in voltage, or ACTION POTENTIAL:

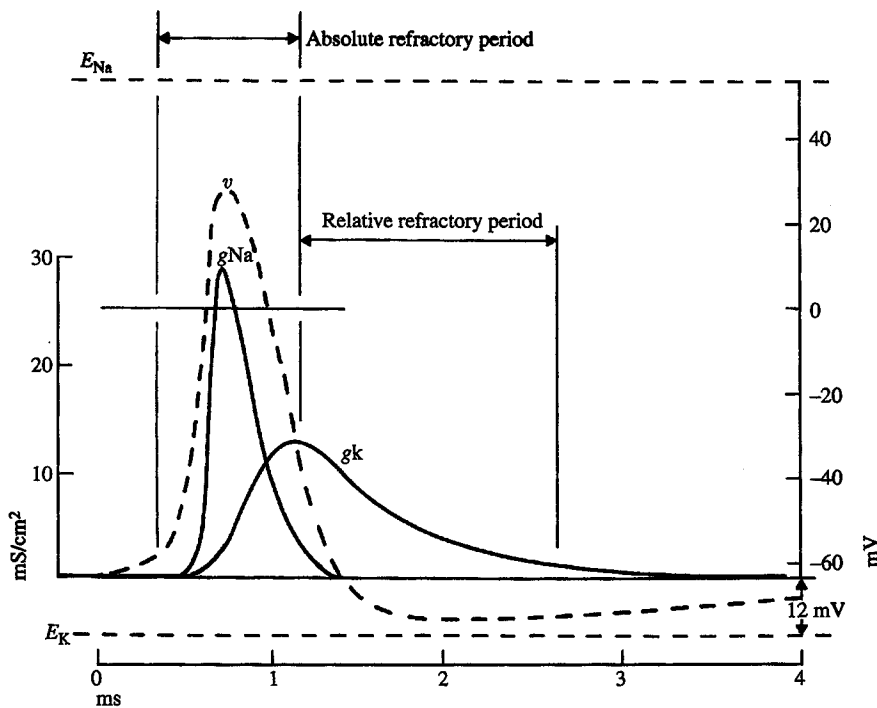
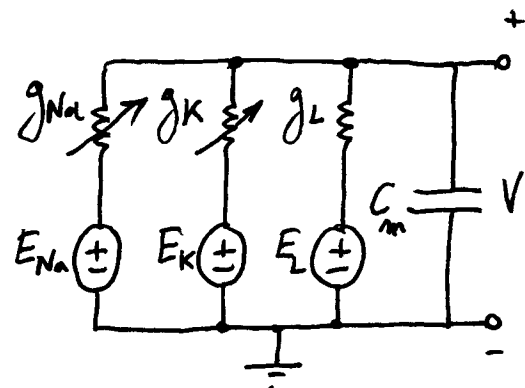

Figure 4.2 Model-generated transmembrane potential (v_m) and membrane ionic conductance changes for sodium (g_{Na}) and potassium (g_K) during the action potential. These waveforms are obtained by solving the differential equations developed by Hodgkin and Huxley for the giant axon of the squid at a bathing medium temperature of 18.5°C. E_{Na} and E_K are the Nernst equilibrium potentials for Na^+ and K^+ across the membrane. (Modified from A. L. Hodgkin and A. F. Huxley, "A quantitative description of membrane current and its application to conduction and excitation in nerve." *Journal of Physiology*, 1952, 117, 530.)

$$g_{Na} \propto P_{Na}$$

$$g_K \propto P_K$$



$$E_{Na} \approx +60mV$$

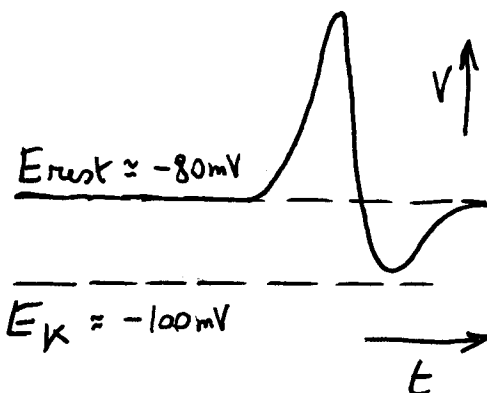

Action potentials propagate along elongated excitable cells giving rise to waves of electrical activity.

- Cardiac cells: fibers of striated muscle tissue generate waves of contractions for pumping of blood
- Neurons and nerves: axons conduct action potentials over large distances for signaling

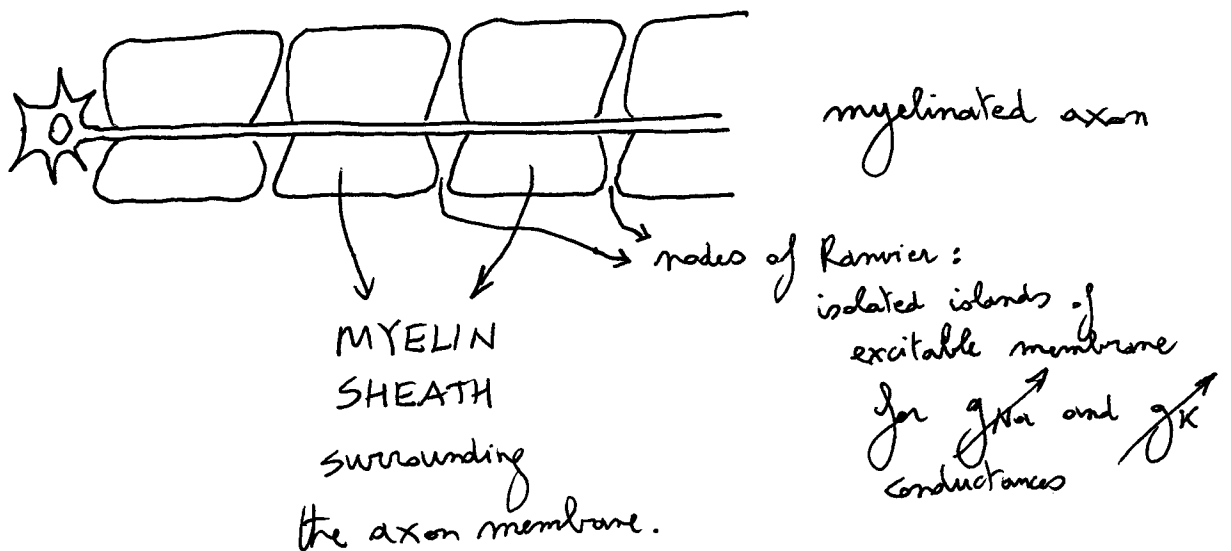
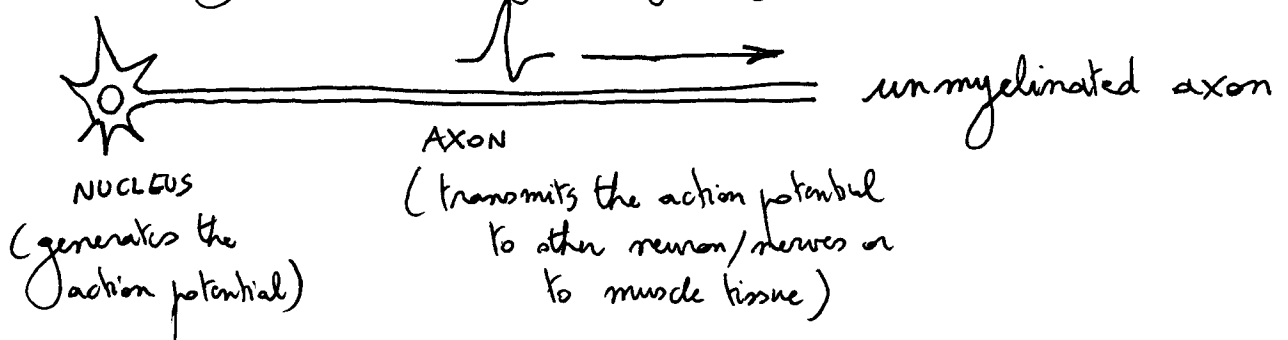

FUNCTION: DECREASED CAPACITANCE \rightarrow shorter delays \rightarrow faster propagation speed